

Rittal CM – Compact System Enclosures



Including
Innovations 2006

Compact class = Top class:
Infinite possibilities

Compact enclosure on the outside, Top enclosure on the inside!



Contents

- Convincing details 3 – 5
- Compact system enclosures Rittal CM, single-door 6
- Compact system enclosures Rittal CM, two-door 7
- Accessories 8 – 18
- Technical details 19

The new **compact system enclosures Rittal CM** combine the case benefits of the AE compact enclosure with the installation diversity of the Top enclosure system TS 8. This symbiosis creates infinite possibilities in the compact class. The Rittal Compact Medium is an attractive alternative to larger enclosures in the AE series, and replaces the old AK series.

**Compatible with
TS 8 accessories**

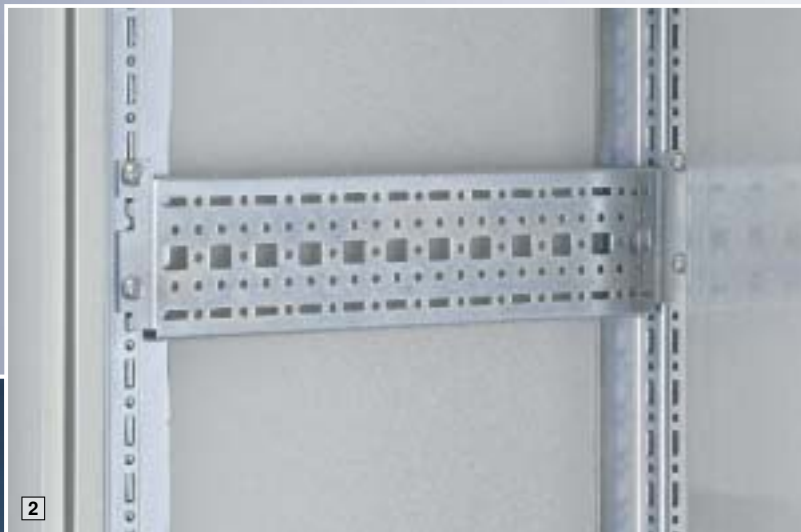

**2 NEW – compatibility with
TS 8 mounting components**

Interior installation with TS 8 accessories is facilitated by pairs of vertical rails for interior installation on the side panels. This TS 8 compatibility, combined with a full range of Rittal system accessories, will transform compact system enclosures into highly flexible solutions for your applications.

Additional horizontal rails for interior installation in the front of the enclosure at the top and bottom provide mounting space for system lights, door operated switches and customer-supplied parts, such as contact hazard protection covers.

**1 NEW – TS 8 modular base/plinth system
also suitable for Rittal CM**

More opportunities, coupled with lower warehousing and assembly costs – this is the winning formula behind the modular base/plinth system TS 8.

Convincing details



1 NEW – All cable entry options covered

More space, more stability and more opportunities for cable entry, thanks to the large base opening and a wide range of gland plate combinations.

Only buy what you really need:

- Gland plates 50, 100, 150 or 250 mm deep
- Section for cable entry (cable clamp strip)
- Cable entry plates and grommets
- EMC gland plate
- Cable glands



2 NEW – Potential equalisation

Provided only electrical equipment is mounted on the mounting plate and there is no chance of a voltage overspill to other conductive parts of the enclosure, automatic potential equalisation (while conforming to DIN EN 60 439-1) eliminates the need for connection of an additional PE conductor.

The new **compact system enclosures Rittal CM** for the configuration of compact controllers also offer a host of other important new installation options, in addition to the infinite possibilities afforded by interior installation with TS 8 compatibility.



3 NEW – Fold, don't swing

This ensures optimum utilisation of the door space, because no swivel area is needed. The lock insert is protected against dirt by the inserted trim panel, see page 13 – 14.



Door stay

Installation without drilling on the perforated door strips, see page 12.



Mounting plate slide block

Populated mounting plates slide easily into the mounting position, see page 11.



4 NEW – Rapid attachment

The mounting plate (folded over at the sides) is inserted at the bottom, and simply secured at the top with clips, leaving both hands free for screw fastening.

5 Exceptional qualities of Rittal CM

The triple surface finish: 1. phosphating, 2. electrophoretic dipcoat priming, and 3. structured powder coating for optimum corrosion protection and resistance to lubricants, detergents and mechanical stresses.

6 Door functions

- Doors with spot-welded, perforated assembly strips (25 mm pitch pattern) for universal interior installation.
- Perfect seal, thanks to the twin edge of the enclosure and optimum compression of the foamed-in seal.

Compact system enclosures Rittal CM

Width: 600 – 800, height: 800 – 1200

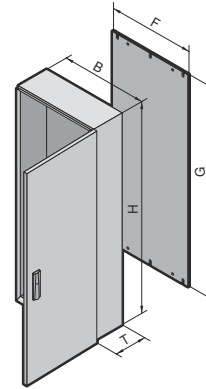

Material:
Sheet steel
Enclosure: 1.5 mm
Door: 2.0 mm
Mounting plate: 3.0 mm

Surface finish:
Enclosure and door:
Dipcoat-primed,
powder-coated on the outside
in textured RAL 7035
Mounting plate: Zinc-plated

Protection category:
IP 55 with selection of the
appropriate gland plates,
see page 8.



Rittal service:

Other sizes, cut-outs and holes
available on request.

Supply includes:
Enclosure with one door, r/h
door hinge, may be swapped to
opposite side, mounting plate,
open base for individual cable
entry.

Detailed drawing,
see page 19.



Width (B) mm	Packs of	600	600	600	600	800	800	800	800	Page	
Height (H) mm		800	1000	1200	1200	1000	1000	1200	1200		
Depth (T) mm		400	400	300	400	300	400	300	400		
Mounting plate width (F) mm		540	540	540	540	740	740	740	740		
Mounting plate height (G) mm		755	955	1155	1155	955	955	1155	1155		
Model No. CM	1	5110.500	5111.500	5112.500	5113.500	5114.500	5115.500	5116.500	5117.500		
Door		1	1	1	1	1	1	1	1		
Base/plinth											
Components front and rear	Height 100 mm	1 set	8601.600	8601.600	8601.600	8601.600	8601.800	8601.800	8601.800	8601.800	15
	Height 200 mm	1 set	8602.600	8602.600	8602.600	8602.600	8602.800	8602.800	8602.800	8602.800	15
Trim panels (sides)	Height 100 mm	1 set	8601.040	8601.040	8601.030	8601.040	8601.030	8601.040	8601.030	8601.040	15
	Height 200 mm	1 set	8602.040	8602.040	8602.030	8602.040	8602.030	8602.040	8602.030	8602.040	15
Accessories											
Rail for interior installation	for height	4	5001.051	5001.052	5001.053	5001.053	5001.052	5001.052	5001.053	5001.053	10
	for width	4	5001.050	5001.050	5001.050	5001.050	5001.051	5001.051	5001.051	5001.051	10
Matching punched section with mounting flange	in the depth	4	8612.140	8612.140	8612.130	8612.140	8612.130	8612.140	8612.130	8612.140	921 ¹⁾
	in the width	4	8612.060	8612.060	8612.060	8612.060	8612.080	8612.080	8612.080	8612.080	921 ¹⁾
Support strips for door		20	4596.000	4596.000	4596.000	4596.000	4598.000	4598.000	4598.000	4598.000	895 ¹⁾
Punched sections with mounting flanges for door		4	8612.050	8612.050	8612.050	8612.050	-	-	-	-	921 ¹⁾
Cable clamp rail		1	5001.080	5001.080	5001.080	5001.080	5001.081	5001.081	5001.081	5001.081	18
Wiring plan pocket Sheet steel, depth 35 mm		1	4116.500	4116.500	4116.500	4116.500	4118.500	4118.500	4118.500	4118.500	12
Rain canopy/vented roof		1	5001.310	5001.310	5001.300	5001.310	5001.320	5001.330	5001.320	5001.330	11
Lock systems											

Standard double-bit insert may be exchanged for lock inserts, see page 14, and folding lever handle, see page 13 and 14.

¹⁾ in Cat. 31.

To order primed enclosures, please add extension .800 to the Model No. Delivery times available on request.



Interface flaps
as programming interface,
for maintenance access and
for connecting to network
structures.
Model No. see Innovations 2006,
page 200.

Base/plinth

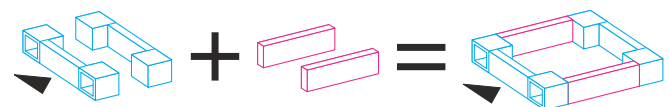

One Model No. for
the **base/plinth**
components
front and rear.

One Model No. for
the **base/plinth**
trim
panels at the sides.

One complete
base/plinth.

Compact system enclosures Rittal CM

Width: 1000 – 1200, height: 1000 – 1400

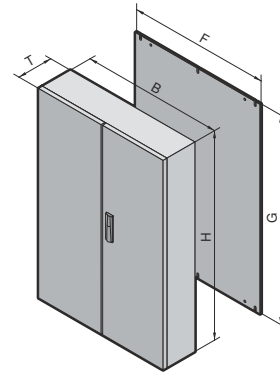

Material:
Sheet steel
Enclosure: 1.5 mm
Door: 2.0 mm
Mounting plate: 3.0 mm

Surface finish:
Enclosure and door:
Dipcoat-primed,
powder-coated on the outside
in textured RAL 7035
Mounting plate: Zinc-plated

Protection category:
IP 55 with selection of the
appropriate gland plates,
see page 8.



Rittal service:

Other sizes, cut-outs and holes
available on request.

Supply includes:
Enclosure with two doors, r/h
door lockable, may be swapped
to opposite side, mounting plate,
open base for individual cable
entry.

Detailed drawing,
see page 19.



Width (B) mm	Packs of	1000	1000	1000	1000	1000	1200	Page
Height (H) mm		1000	1200	1200	1400	1400	1200	
Depth (T) mm		300	300	400	300	400	400	
Mounting plate width (F) mm		940	940	940	940	940	1140	
Mounting plate height (G) mm		955	1155	1155	1355	1355	1155	
Model No. CM	1	5118.500	5119.500	5120.500	5121.500	5122.500	5123.500	
Doors		2	2	2	2	2	2	

Base/plinth									
Components front and rear	Height 100 mm	1 set	8601.000	8601.000	8601.000	8601.000	8601.000	8601.200	15
	Height 200 mm	1 set	8602.000	8602.000	8602.000	8602.000	8602.000	8602.200	15
Trim panels (sides)	Height 100 mm	1 set	8601.030	8601.030	8601.040	8601.030	8601.040	8601.040	15
	Height 200 mm	1 set	8602.030	8602.030	8602.040	8602.030	8602.040	8602.040	15

Accessories									
Rail for interior installation	for height	4	5001.052	5001.053	5001.053	5001.054	5001.054	5001.053	10
	for width	4	5001.052	5001.052	5001.052	5001.052	5001.052	5001.053	10
Matching punched section with mounting flange	in the depth	4	8612.130	8612.130	8612.140	8612.130	8612.140	8612.140	921 ¹⁾
	in the width	4	8612.000	8612.000	8612.000	8612.000	8612.000	8612.020	921 ¹⁾
Support strips for door		20	4309.000	4309.000	4309.000	4309.000	4309.000	4596.000	895 ¹⁾
Punched sections with mounting flanges for door		4	8612.040	8612.040	8612.040	8612.040	8612.040	8612.050	921 ¹⁾
Cable clamp rail		1	5001.082	5001.082	5001.082	5001.082	5001.082	5001.083	18
Wiring plan pocket Sheet steel, depth 35 mm		1	4115.500	4115.500	4115.500	4115.500	4115.500	4116.500	12
Rain canopy/vented roof		1	5001.340	5001.340	5001.350	5001.340	5001.350	5001.360	11

Lock systems
Standard double-bit insert may be exchanged for lock inserts, see page 14,
and folding lever handle, see page 13 and 14.

¹⁾ in Cat. 31.

To order primed enclosures, please add extension .800 to the Model No. Delivery times available on request.



Section for cable entry, rear,
suitable for integration into the
modular gland plate concept,
see page 9.



Cable glands
of polyamide or brass,
Model No. see page 16.

Compact system enclosures Rittal CM

Accessories



Gland plates

Select suitable gland plates depending on the application. The following examples illustrate how individually cable entry may be organised. Potential equalisation is provided via assembly components and earthing points.

Combination options:

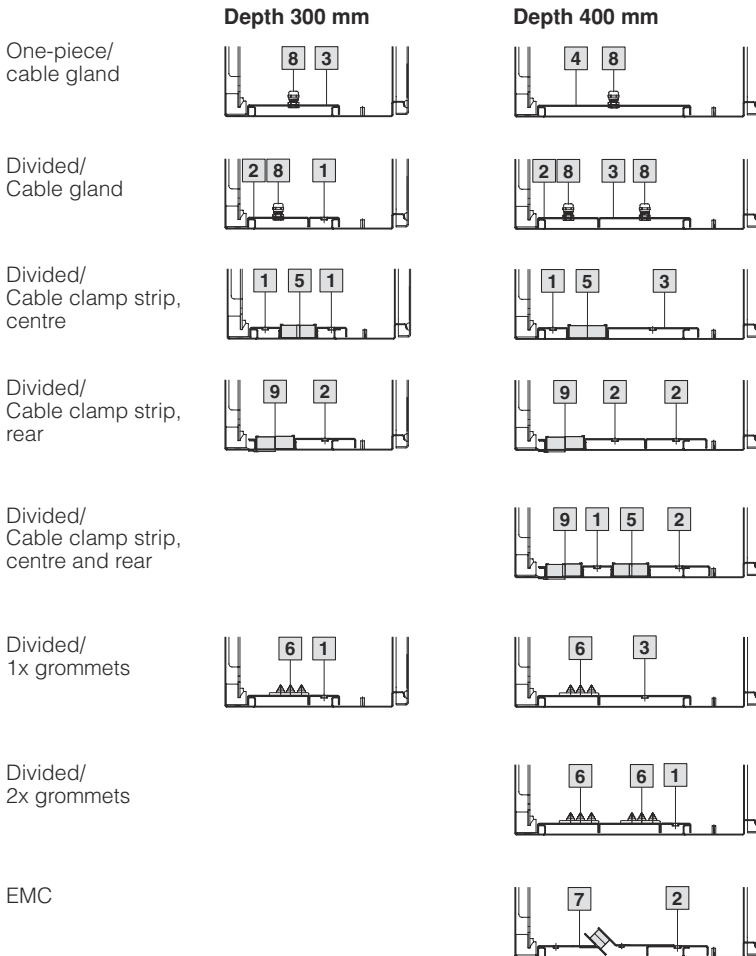

Design	For enclosure width mm			
	600	800	1000	1200
	Model No.			
1	5001.210	5001.211	5001.212	5001.213
2	5001.214	5001.215	5001.216	5001.217
3	5001.218	5001.219	5001.220	5001.221
4	5001.222	5001.223	5001.224	5001.225
6	5001.226¹⁾	5001.227¹⁾	5001.228¹⁾	5001.229¹⁾

¹⁾ Cable entry grommets, see page 9.

Material:

Sheet steel, zinc-plated, passivated

Protection category:

IP 55 if mounted correctly.

Supply includes:

Assembly parts.

Note:

For greater stability and universal cable entry, the base opening is divided in the width for 1000 and 1200 mm wide enclosures, and is suitable for various configurations.

Key:

- 1** Gland plate, depth 50 mm
- 2** Gland plate, depth 100 mm
- 3** Gland plate, depth 150 mm
- 4** Gland plate, depth 250 mm
- 5** Section for cable entry, centre, see page 9.
- 6** Cable entry plates, depth 100 mm, see above. Grommets, see Cat. 31, page 965.
- 7** EMC gland plate, see Cat. 31, page 958.
- 8** Cable glands, see page 16.
- 9** Section for cable entry, rear, see page 9.

Order example:

- CM 5120.500 (W/H/D 1000 x 1200 x 400 mm)
- On left, gland plates divided into two with cable clamp strip
 - On right, one-piece gland plate

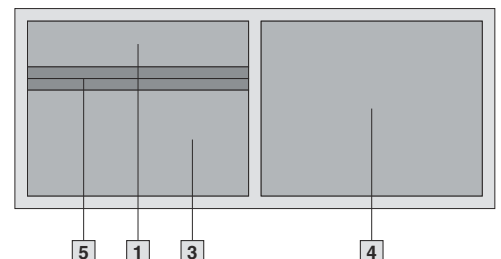

You will need:

- 5** 2 sections for cable entry, centre, TS 8802.100, see page 9. (Packs of 4)
- 1** 1 gland plate, depth 50 mm, 5001.212
- 3** 1 gland plate, depth 150 mm, 5001.220
- 4** 1 gland plate, depth 250 mm, 5001.224



Section for cable entry, centre

For top-mounting on the gland plates. The better alternative to the foam rubber cable clamp strip, thanks to:

- Easier mounting
- Full-surface support
- High level of sealing of cables inserted into the enclosure.

Supply includes:

1 set =
2 sections for base plate,
each with bonded seal.

For enclosure width mm	Packs of	Model No. TS
600	1 set	8802.060
800	1 set	8802.080
1000	2 sets	8802.100
1200	2 sets	8802.120



Section for cable entry, rear

Unlike the section for cable entry, centre, the rear section is mounted directly onto the base opening. In this way, the cables may be routed directly onto a cable clamp rail without large bending radii. In conjunction with the new cable clamp rail, optimum adjustment between the cable entry and mounting plate can be achieved.

Material:

Extruded aluminium section,
PU foam seal,
Cross-section: 30 x 25 mm

Protection category:

IP 55 if mounted correctly.

For enclosure width mm	Packs of	Model No. TS
600	1 set	8802.065
800	1 set	8802.085
1000	2 sets	8802.105
1200	2 sets	8802.125

Supply includes:

1 set =
1 section for base opening,
1 section for base plate,
each with bonded seal.



Accessories:

Cable clamp rail,
see page 18.



Cable entry grommets

In conjunction with the cable entry plate, simple and fast sealing of cables inserted in the base area of enclosures.

Protection category:

IP 55 if mounted correctly.

Cables per grommet	max. Ø mm	Packs of	Model No. TS
8	13	25	4316.000
3	21	25	4317.000
1	47	25	4318.000



Connector grommets

Suitable for cable diameters from 8 to 36 mm.

Packs of	Model No. TS
10	4311.000



Cover plate

To conceal the entire base opening.

Note:

May be used as a cover in enclosures that are inverted (available on request).

Material:

Sheet steel

Colour:

Textured RAL 7035

Protection category:

IP 55

Supply includes:

Assembly parts.

For enclosure		Model No. CM
W mm	D mm	
600	300	5001.100
800		5001.110
1000		5001.120
600	400	5001.130
800		5001.140
1000		5001.150
1200		5001.160

Compact system enclosures Rittal CM

Accessories



Rails for interior installation

For mounting on the threaded bolts provided on the enclosure.
With TS system punchings on three sides.

Material:

Sheet steel, zinc-plated, passivated

Supply includes:

Assembly parts.

For enclosure height/width mm	Packs of	Model No. SZ
600	4	5001.050
800	4	5001.051
1000	4	5001.052
1200	4	5001.053
1400	4	5001.054



Installation accessories	Model No.				Cat. 31, page
	For depth mm				
	300	400			
1 TS punched section with mounting flange, 17 x 73 mm for the outer level	8612.130	8612.140			921
2 TS support strip for the outer level	8800.125	4694.000			924
3 TS punched rail 18 x 38 mm	–	8612.240			923
20 PS punched rail 23 x 23 mm with mounting bracket TS	–	4169.000			925
	For width (mm)				Cat. 31, page
	600	800	1000	1200	
4 TS punched section with mounting flange, 17 x 73 mm for the inner level	8612.060	8612.080	8612.000	8612.020	921
5 TS support strip for the inner level	8800.130	4579.000	–	–	924
7 PS punched section without mounting flange 23 x 73 mm, with support bracket TS (alternatively with one or two punched rails 23 x 23 mm)	4376.000	4377.000	4382.000	4378.000	925

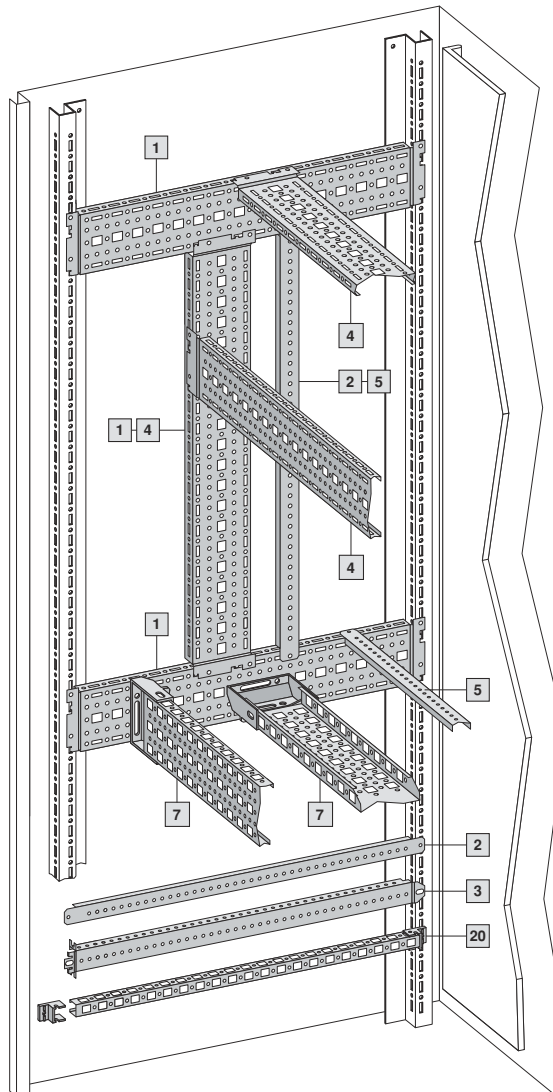

Partial mounting plates

for universal interior installation, see Cat. 31, page 913.

Installation:

static via TS punched sections with mounting flanges mounted in the depth **1**, horizontally hinged via PS punched sections without mounting flanges mounted in the depth **7** and hinge attachment for partial mounting plates, see Cat. 31, page 914.



Mounting plate slide block

In this way, populated mounting plates slide easily into the mounting position for installation and/or clip-fastening.

Benefits:

- Installation without drilling
- Simply screw-fasten to the existing holes in the mounting plate
- May be reused, unscrew to detach

Material:

Polyamide

Colour:

Similar to RAL 9011

Supply includes:

Assembly parts.

Packs of	Model No. CM
2	5001.070



Rain canopy/vented roof plate

Reliable protection for outside siting – with water run-off to the rear. Easily retro-fitted.

Benefits:

- Mounting via the two holes in the top of the CM
- At the front, with integrated ventilation holes at the top

Note:

For outdoor siting, we generally recommend a rain canopy above the enclosure or the gap between the door and the enclosure, in order to protect against water and UV radiation. The tests of IP protection categories for water protection (2nd code number to EN 60 529) cannot be compared with an enclosure sited outdoors or under similar conditions.

Material:

Sheet steel

Surface finish:

Powder-coated in textured RAL 7035

Supply includes:

Assembly parts.



Accessories:

Wall mounting brackets SZ 2503.0X0 and SZ 2508.0X0 may be used, see Cat. 31, page 905.

Width mm	Depth mm	Model No.
600	300	5001.300
600	400	5001.310
800	300	5001.320
800	400	5001.330
1000	300	5001.340
1000	400	5001.350
1200	400	5001.360



Rittal service:

The CM enclosures may be supplied prepared for passive ventilation with:

- Roof cut-out
- Structure inverted (mounting plate accommodation)

on request.

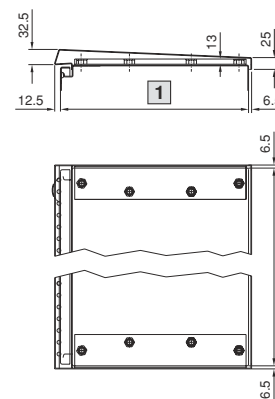

1 Enclosure depth
2 Enclosure width



Utility lectern

When required for servicing, it folds down quickly with a maximum support area, and after use is stowed away in a space-saving design. Load capacity: max. 30 kg.

Material:

Sheet steel

Colour:

RAL 7035

Support area		For door width mm	Model No. TS
Width mm	Depth mm		
413	400	600	4638.600
613	400	800	4638.800

Compact system enclosures Rittal CM

Accessories



Hinges, 180°

For retrospective conversion of standard doors with 130° hinges. One pack is for one door – i.e. with two-door enclosures, two packs will be required.

Material:
Die-cast zinc

Colour:
RAL 9011/9006

Supply includes:
Assembly parts.

Note:
When buying two CM enclosures, position the hinges on the outside.



Packs of	Model No. CM
3	5001.000

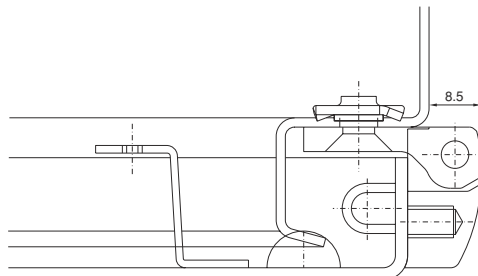

Door stay

Prevents the door from banging. To secure the door, lift the spring-mounted bar, swing against the enclosure edge fold, and snap into position.

Benefits:

- Installation without drilling
- Simply screw-fasten to the existing holes in the perforated door strip
- Suitable for mounting at the top and bottom
- For one and two-door CM enclosures

Material:
Polyamide

Colour:
Similar to RAL 9011

Supply includes:
Assembly parts.



Packs of	Model No. CM
2	2519.100



Wiring plan pockets of sheet steel, depth 35 mm

For fastening to the perforated door strip at any height.

Colour:
RAL 7035

Supply includes:
Assembly screws.

To fit door width mm	Clearance openings mm			Model No. TS
	W	H	D	
500	355	260	35	4115.500
600	455	260	35	4116.500
800	655	260	35	4118.500

Other wiring plan pockets, see Cat. 31, page 897 – 898.



Earth straps

For configuring a reliable earthing connection with perfect contact.

- With ring terminals in M8 to match the earthing screws
- Length-optimised and ready to install

Cross-section mm ²	Length mm	Packs of	Model No. SZ
4	170	5	2564.000
16	170	5	2565.000
25	170	5	2566.000
4	300	5	2567.000
10	300	5	2565.120
16	300	5	2568.000
25	300	5	2569.000



Folding lever handle

As the handle does not take up any swing space, due to its folding mechanism, the door surface area may be maximised for installed equipment.

Colour:

Body: Similar to RAL 9005
Handle: Similar to RAL 9006

Dimension:

Length: 242 mm (with inserted trim panel)
Width: 50 mm
Depth: 17.5 mm



Folding lever handle for lock inserts

Prepared for the installation of:

- Semi-cylinders with an overall length of 40 or 45 mm (to DIN 18 254)
- Lock inserts
- Lock and push-button inserts



Folding lever handle for padlock and lock inserts

Prepared for the installation of:

- Semi-cylinders with an overall length of 40 or 45 mm (to DIN 18 254)
- Lock inserts
- Lock and push-button inserts

With additional shackle (hole diameter 8 mm) for a padlock.

Packs of	Model No. CM
1	5001.060

+ Accessories:

Lock inserts, see page 14.
SZ lock and push-button inserts, see page 14.

Packs of	Model No. CM
1	5001.062

+ Accessories:

Lock inserts, see page 14.
SZ lock and push-button inserts, see page 14.



Folding lever handle prepared for lock system KESO.

Packs of	Model No. CM
1	5001.063

Compact system enclosures Rittal CM

Accessories



Folding lever handle prepared for ASSA lock system.

Packs of	Model No. CM
1	5001.064



Folding lever handle with lock insert E1

Only for use with **VW, Audi, SEAT, SkodaAuto**.
Supplied without key.
Other VW locks available on request.

Packs of	Model No. CM
1	5001.061



Lock inserts

For folding lever handle CM 5001.060,
CM 5001.062 and standard CM lock (in exchange
for the standard double-bit lock insert).

Design	Model No. TS
7 mm square	8611.100
8 mm square	8611.110
6.5 mm triangular	8611.220
7 mm triangular	8611.120
8 mm triangular	8611.130
Screwdriver	8611.140
Daimler	8611.150
3 mm double-bit	8611.160
Fiat	8611.170



Lock and push-button inserts

For installation in the folding lever handle
CM 5001.060 and CM 5001.062.

Design	Model No. SZ
Lock insert lock no. 3524 E	2467.000 ¹⁾
Push-button insert	2468.000
Lock and push-button insert, lock no. 2123 E; No other lock is possible	2469.000 ¹⁾

¹⁾ with 2 keys



Base/plinth components front and rear

Base/plinth component consisting of one trim panel and two pre-configured corner pieces. In 200 mm high base/plinth components, one trim panel is divided into two for cable entry.

Material:

Sheet steel, spray-finished in RAL 7022
Cover caps plastic RAL 9005/7035

Supply includes:

1 set =
2 base/plinth components, 4 cover caps,
4 screws and captive nuts M12
for attachment to the enclosure.

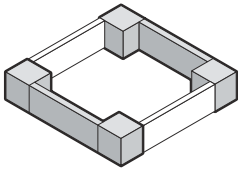

For enclosure width mm	Model No. TS	
	100 mm high	200 mm high
600	8601.600	8602.600
800	8601.800	8602.800
1000	8601.000	8602.000
1200	8601.200	8602.200

+ Accessories:

Base assembly plate SO 2817.000, see page 15.

Detailed drawing,
see Cat. 31, page 836.

German patent no. 198 60 408



Base/plinth trim, side

For mounting between the base/plinth components. At 200 mm height, two 100 mm base/plinth trims may be used.

Material:

Sheet steel, spray-finished in RAL 7022

Supply includes:

1 set =
2 base/plinth trim panels, including parts for attaching to the base/plinth components.

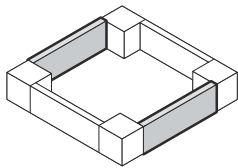

For enclosure depth mm	Model No. TS	
	100 mm high	200 mm high
300	8601.030	8602.030
400	8601.040	8602.040

+ Accessories:

Fastening bolts for buying base/plinth trim, see page 15.

Detailed drawing,
see Cat. 31, page 836.



Base assembly plate for base/plinth

For fastening the plinth to the floor without moving the enclosure or the bayed enclosure suite. For assembly screws up to 12 mm Ø.

Material:

Sheet steel, zinc-plated, passivated

Packs of	Model No. SO
10	2817.000



Fastening bolts for base/plinth

For mounting on base/plinth trim panels, side. The lockable assembly bolt allows the installation of cable clamp rails and standard C rails.

Material:

Hexagon steel, zinc-plated, passivated,
19 mm across flats

For base/plinth trim panel height mm	Packs of	Model No. SZ
100	10	2819.000
200	10	2819.200

+ Accessories:

Cable clamp rail, see Cat. 31, page 979.

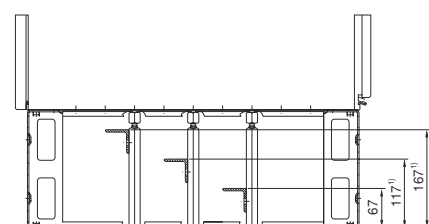

¹⁾ only for height 200 mm

Compact system enclosures Rittal CM

Accessories



Cable gland, brass

Material:
Nickel-plated brass, neoprene seal

Protection category:
IP 68 (5 bar, 30 min.) to EN 60 529/10.91

Approval:
VDE tested to EN 50 262

Size	Cable diameter mm	Packs of	Model No. SZ
M12 x 1.5	3 – 6.5	15	2411.800
M16 x 1.5	4.5 – 10	15	2411.810
M20 x 1.5	6 – 12	10	2411.820
M25 x 1.5	11 – 17	10	2411.830
M32 x 1.5	15 – 21	5	2411.840
M40 x 1.5	19 – 28	4	2411.850
M50 x 1.5	27 – 38	2	2411.860
M63 x 1.5	34 – 44	1	2411.870



Cable gland, polyamide

Material:
Polyamide 6, neoprene seal

Colour:
RAL 7035

Protection category:
IP 68 (5 bar, 30 min.) to EN 60 529/10.91

Approval:
VDE tested to EN 50 262

Size	Cable diameter mm	Packs of	Model No. SZ
M12 x 1.5	3 – 6.5	50	2411.600
M16 x 1.5	4.5 – 10	50	2411.610
M20 x 1.5	6 – 12	50	2411.620
M25 x 1.5	11 – 17	25	2411.630
M32 x 1.5	15 – 21	15	2411.640
M40 x 1.5	19 – 28	5	2411.650
M50 x 1.5	27 – 38	5	2411.660
M63 x 1.5	34 – 44	3	2411.670



Multi-seal inserts and bungs

See Cat. 31, page 973.



Wall mounting bracket

Supply includes:
Assembly parts for mounting on the enclosure.

Material	Wall distance mm	Packs of	Model No. SZ
Sheet steel zinc-plated, passivated	40	1	2503.000¹⁾
		4	2503.010
	10	1	2508.000¹⁾
		4	2508.010

¹⁾ Without assembly parts.

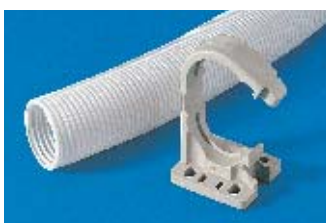

Cable conduit and cable conduit holder

For secure cable routing e.g. from the enclosure or mounting plate to the door. Option of attaching the cable conduit holder to the punched door strips or rails for interior installation with no drilling required.

Attachment facility for standard commercially available cable ties is provided on the cable conduit holder, so that cables may be attached upon entry to/exit from the cable conduit.

Material:
Cable conduit: Polythene
Cable conduit holder: Polyamide

Cable conduit

Internal Ø mm	Packs of	Model No. SZ
16	25 m	2595.000
29	25 m	2589.000
36	25 m	2596.000
48	25 m	2590.000

Cable conduit holder

For cable conduit Ø mm	Packs of	Model No. SZ
16	20	2593.000
29	20	2591.000
36	20	2594.000
48	20	2592.000





Dust guard trim

To protect against deposits on the upper edge of the door and between the enclosure and the door. Cut the door protection strip to length according to the enclosure width. Drill the enclosure and mount the strip using the adhesive strips and screws.

Material:
Plastic, UV-resistant

Colour:
Similar to RAL 7024

Length mm	Model No. SZ
1200	2426.500

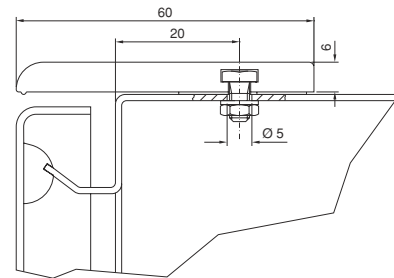

Eyebolts

For crane transportation of enclosures, with reinforcement plate to be inserted underneath. Mounting via the two holes in the top of the CM. Thread: M12

Supply includes:
Eyebolts, reinforcement plates.

Packs of	Model No. CM
2	2509.500

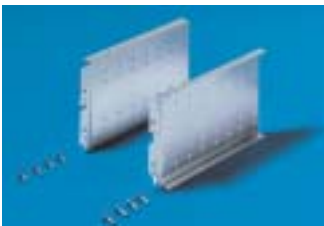

Support rail, locatable

Suitable for mounting in CM on a rail for internal installation.

Integral 25 mm pitch pattern of holes to accommodate:

- Mounting plate, small
- Customer-supplied parts

Static load: max. 15 kg

Packs of	Model No. TS
1 set	8612.200

Detailed drawing,
see Cat. 31, page 915.



Mounting plate, small

Provides a second, depth-adjustable mounting level.

For external mounting on:

- Support rail TS, locatable, depth-adjustable on a 25 mm pitch pattern,
- Punched sections with mounting flanges mounted in the enclosure depth.

Enclosure width mm	Packs of	Model No. TS
600	1	8612.600
800	1	8612.800

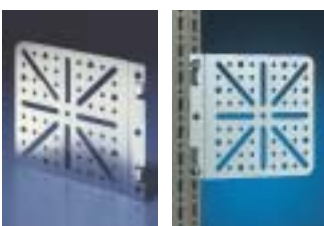

Mounting plates

Locatable

On the vertical mounting rail and the perforated rail on the door.

Material:
Sheet steel, zinc-plated, passivated

Supply includes:
Assembly screws.

Packs of	Model No. TS
4	8612.400

Detailed drawing,
see Cat. 31, page 929.

Compact system enclosures Rittal CM

Accessories



Cable clamp rail

C section

For strain relief with cable entry. The length of the cable clamp rail is tailored to the width of the CM and TS mounting plate. The mounting bracket included with the supply supports three different installation situations on the mounting plate:

- 1 straight, at a distance of 23 mm from the mounting plate
- 2 straight, at a distance of 10 mm from the mounting plate
- 3 tilted, towards the mounting plate

Material:

Sheet steel

Surface finish:

Zinc-plated, passivated

Supply includes:

Two mounting brackets and assembly screws.

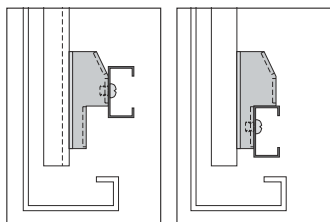

1

2

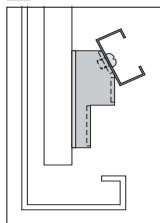

3

For enclosure width mm	Length mm	Model No. CM
600	499	5001.080
800	699	5001.081
1000	899	5001.082
1200	1099	5001.083



Accessories:

Cable clamps for C rails

For cable diameter mm	Packs of	Model No. DK
6 – 14	25	7077.000
12 – 18	25	7078.000
18 – 22	25	7097.000
22 – 26	25	7097.220
26 – 30	25	7097.260
30 – 34	25	7097.300
34 – 38	25	7097.340
38 – 42	25	7098.000
42 – 56	25	7098.100
56 – 64	25	7099.000



Divider kits

for swing frame, large

For enclosure height 1200 mm.

To accommodate the 22 U swing frames:

- Without trim panel, SR 2322.700 (see Cat. 31, page 995)
- With side trim panel, SR 2323.235 and
- With centre trim panel, SR 2324.235 (see Cat. 31, page 997)

For enclosure width mm	Hinge	Model No. CM
600	130°	1985.500
800	130°	1986.500¹⁾

¹⁾ For swing frame, large with trim panel, the 180° hinge CM 1978.200 may be retrofitted.



System windows

To fit door widths 600 and 800 mm and other suitably large areas. Comprises a robust frame with single-pane safety glass. See Cat. 31, page 877.



Operating panel

For fixed or hinged surface mounting. Cam lock and viewing window available as accessories. See Cat. 31, page 880.



Partial mounting plates

Second mounting level, set forward, choice of static or hinged installation. See Cat. 31, page 913.



Bracket, locatable

Mounted on rails for interior installation. With 200 mm support surface for shelves, cable clamp rails, partitioning plates etc. See Cat. 31, page 951.



Compact light

Easy drillless mounting, optionally clip or screw-fastened to the rails for interior installation or magnetically attached to surfaces. See Innovations 2006, page 195.



Signal pillars

With LED or incandescent lamp, compact or modular, plus an extensive range of accessories. See Cat. 31, page 1041.

Other accessories

can be found in Catalogue 31, such as

- **Viewing panels/operating panels** from page 877
- **Wiring plan pockets** from page 897
- **Partial mounting plates** from page 913
- **System lights** from page 954
- **Earthing** from page 960
- **Signal pillars** from page 1041
- **Cable ducts** page 978
- **Cable glands** from page 973
- **Power distribution components** from page 299
- **System climate control** from page 579
- **Wiring plan lectern** from page 896

Compact system enclosures Rittal CM

Page 6/7

CM 5110.500 – 5117.500

CM 5118.500 – 5123.500

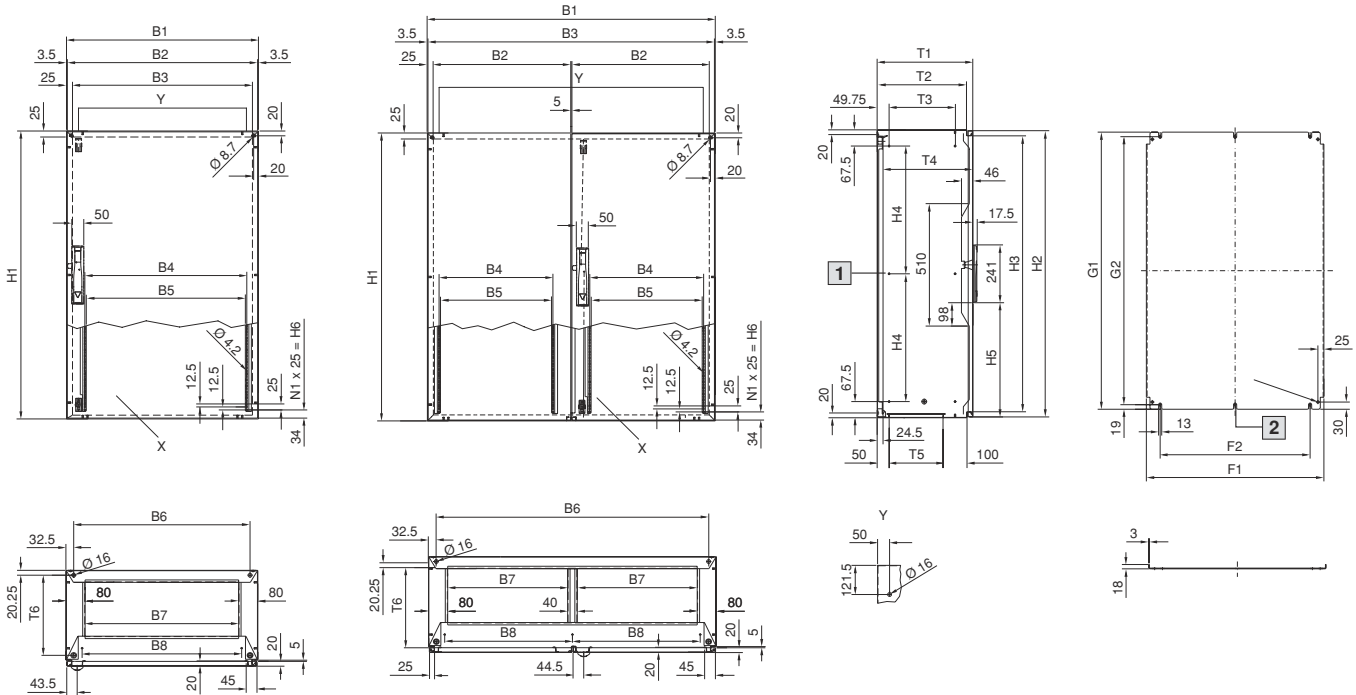

X Door interior view

B = Width

Y Hole for eyebolts

T = Depth

1 Does not apply to H = 800

2 Only for enclosure width from 1000 mm

Model No. CM	Enclosure width mm																Enclosure height mm						Enclosure depth mm						Mounting plate			
	B1	B2	B3	B4	B5	B6	B7	B8	H1	H2	H3	H4	H5	H6	N1	T1	T2	T3	T4	T5	T6	Height mm		Width mm								
	G1	G2	F1	F2																												
5110.500	600	593	550	475	483	535	440	465	800	793	750	665	276	725	29	400	374.5	275	373	224.5	334	755	717	540	425							
5111.500	600	593	550	475	463	535	440	465	1000	993	950	432.5	376	925	37	400	374.5	275	373	224.5	334	955	917	540	425							
5112.500	600	593	550	475	463	535	440	465	1200	1193	1150	532.5	476	1125	45	300	274.5	175	273	124.5	234	1155	1117	540	425							
5113.500	600	593	550	475	463	535	440	465	1200	1193	1150	532.5	476	1125	45	400	374.5	275	373	224.5	334	1155	1117	540	425							
5114.500	800	793	750	675	663	735	640	665	1000	993	950	432.5	376	925	37	300	274.5	175	273	124.5	234	955	917	740	625							
5115.500	800	793	750	675	663	735	640	665	1000	993	950	432.5	376	925	37	400	374.5	275	373	224.5	334	955	917	740	625							
5116.500	800	793	750	675	663	735	640	665	1200	1193	1150	532.5	476	1125	45	300	274.5	175	273	124.5	234	1155	1117	740	625							
5117.500	800	793	750	675	663	735	640	665	1200	1193	1150	532.5	476	1125	45	400	374.5	275	373	224.5	334	1155	1117	740	625							
5118.500	1000	494	950	375	363	935	400	432.5	1000	993	950	432.5	376	925	37	300	274.5	175	273	124.5	234	955	917	940	825							
5119.500	1000	494	950	375	363	935	400	432.5	1200	1193	1150	532.5	476	1125	45	300	274.5	175	273	124.5	234	1155	1117	940	825							
5120.500	1000	494	950	375	363	935	400	432.5	1200	1193	1150	532.5	476	1125	45	400	374.5	275	373	224.5	334	1155	1117	940	825							
5121.500	1000	494	950	375	363	935	400	432.5	1400	1393	1350	632.5	576	1325	53	300	274.5	175	273	124.5	234	1355	1317	940	825							
5122.500	1000	494	950	375	363	935	400	432.5	1400	1393	1350	632.5	576	1325	53	400	374.5	275	373	224.5	334	1355	1317	940	825							
5123.500	1200	594	1150	475	463	1135	500	532.5	1200	1193	1150	532.5	476	1125	45	400	374.5	275	373	224.5	334	1155	1117	1140	1025							

All in all – solutions from Rittal



Industrial enclosures

Small enclosures · Compact enclosures · Large enclosures
Products for the human/machine interface · Console systems
Material: sheet steel, stainless steel, aluminium and plastic
Industrial network technology · Input and signalling devices
Solutions for EMC and Ex · Cable glands



Power distribution



Electronic packaging



System climate control



IT Solutions



Communication Systems

Rittal has one of the largest ranges of enclosures available for immediate delivery. However, Rittal also supplies integrated solutions – up to Level 4. This comprises mechanical installation, power supply, electronic components, climate control and central monitoring. For all of your requirements.

Fully assembled and functional. Wherever in the world you develop and implement solutions for yourself and your customers, we are close at hand. The global alliance between production, distribution and service guarantees closeness to the customer. Worldwide!

07/06 · E166

Rittal Limited · Braithwell Way · Hellaby Industrial Estate · Hellaby · Rotherham · S Yorks S66 8QY
Tel.: (01709) 704000 · Fax: (01709) 701217 · www.rittal.co.uk · eMail: information@rittal.co.uk



Switch to perfection **RITTAL**